



Powered
by Vodafone

CellcomPrime

Advanced GSM Intercom

- Calls your home phone and mobiles on roll-over when visitor presses call button.
- Never miss a visitor with mobile calling.
- Works with any standard contract or Pre-Pay GSM Micro SIM card.
- Comes with optional Vodafone™ 12 month contract SIM, unlimited calls and texts (UK/IRE only) (Please check out www.aesglobaltelecom.com for sim information)
- Free home owner app to trigger gates, set up auto opening and closing times, create new access codes, receive notifications on entry, etc.
- Free installer app for remote programming and diagnostics.





Set automatic gate open & close times.
 Do-not-disturb watershed time.
 User history log to your phone.
 Illuminated call button and keypad.

Add keypad codes by App.
 Issue time restricted codes.
 High gain antenna as standard!
 2x Relays

Technical Details			
Dial Out Numbers	4	Relays	2
Permanent Codes	200	Relay Type	N/C and N/O
Time Restricted Codes	20	Relay Load	2 amps, 24v ac max
Temporary Codes	30	Power Consumption	300mA on dial out, 2amp peak demand
Automatic Trigger Events per Week	40	Modem Models	4G Europe, 4G USA, 4G AUS/NZ
Caller ID Numbers	100	Power Supply	24v dc (24v 2A dc adaptor included)
Time Restricted Caller ID Numbers	20		

Home Owner /User App

- Create a list of all your installs for later editing or diagnostics.
- Complete menu of all parameters for editing by app.
- Program auto opening and closing times.
- Program phone numbers easily!

*App images for illustration purposes only.

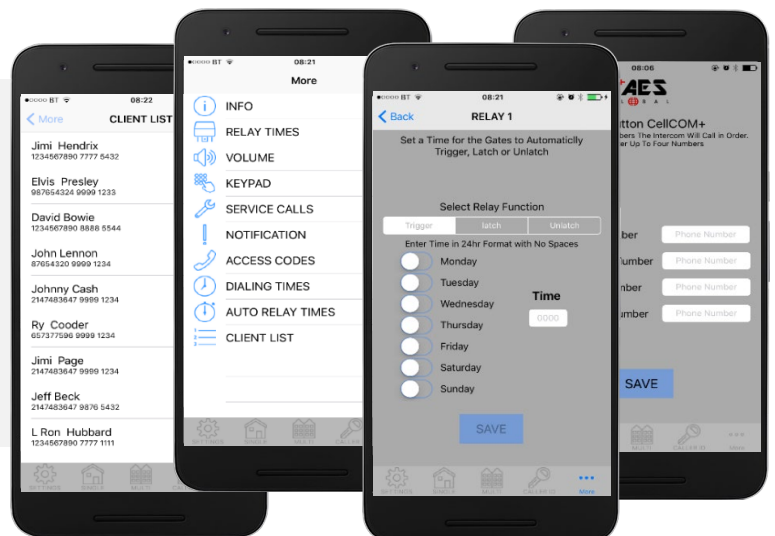



Imperial Panel

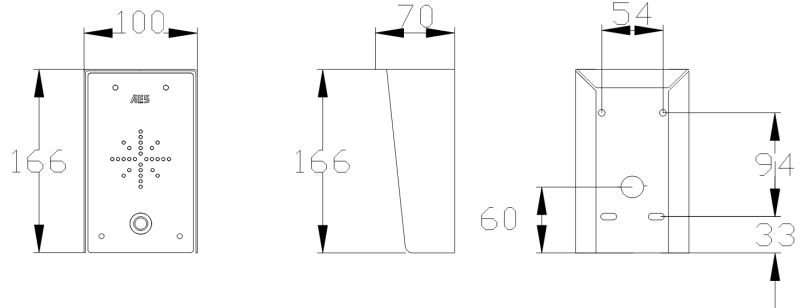

Ultra stylish all black panel with textured powder coated aluminium hood and gloss black acrylic fascia trim over a tough metal back plate. Complete with modern white illuminated push button.

PRIME6-IMP/4GE	Europe
PRIME6-IMP/4GA	USA
PRIME6-IMP/4GSA	Australia & NZ

Imperial Panel with Keypad

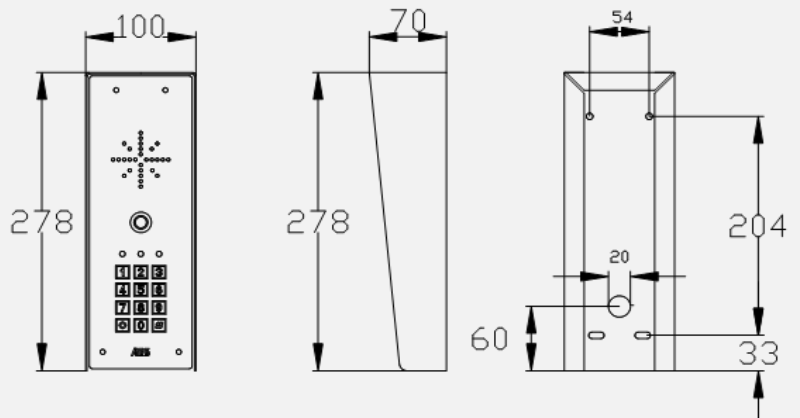

Ultra stylish all black panel with textured powder coated aluminium hood and gloss black acrylic fascia trim over a tough metal back plate. Complete with modern white illuminated buttons.

PRIME6-IMP/4GE	Europe
PRIME6-IMP/4GA	USA
PRIME6-IMP/4GSA	Australia & NZ



Architectural Panel

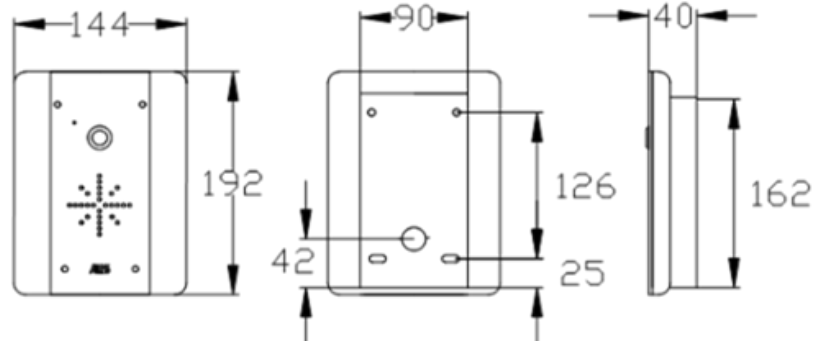

Stylish curved architectural model. Constructed from BS316 marine grade stainless steel and finished with gloss black acrylic trim. Modern blue backlighting.

PRIME6-AB/4GE	Europe
PRIME6-AB/4GA	USA
PRIME6-AB/4GSA	Australia & NZ

Architectural Panel with Keypad

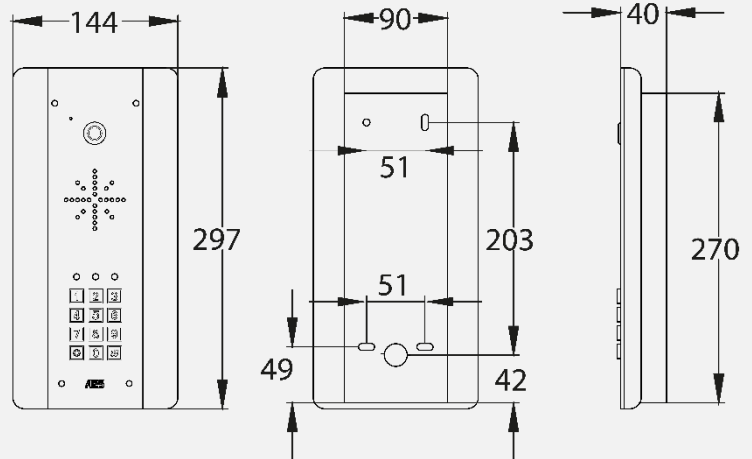

Stylish curved architectural model. Constructed from BS316 marine grade stainless steel and finished with gloss black acrylic trim. Modern blue backlighting with integrated keypad.

PRIME6-ABK/4GE	Europe
PRIME6-ABK/4GA	USA
PRIME6-ABK/4GSA	Australia & NZ



Architectural Panel



4G

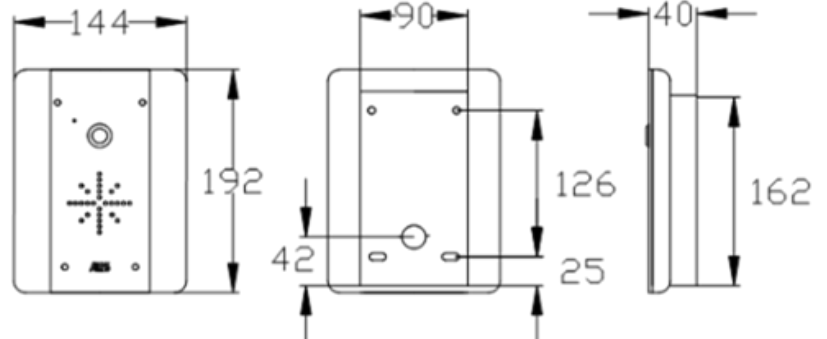

Stylish curved architectural model in an attractive and rugged all brushed BS316 marine grade stainless steel with modern cool white back lighting illumination.

PRIME6-AS/4GE	Europe
PRIME6-AS/4GA	USA
PRIME6-AS/4GSA	Australia & NZ

Architectural Panel with Keypad



4G

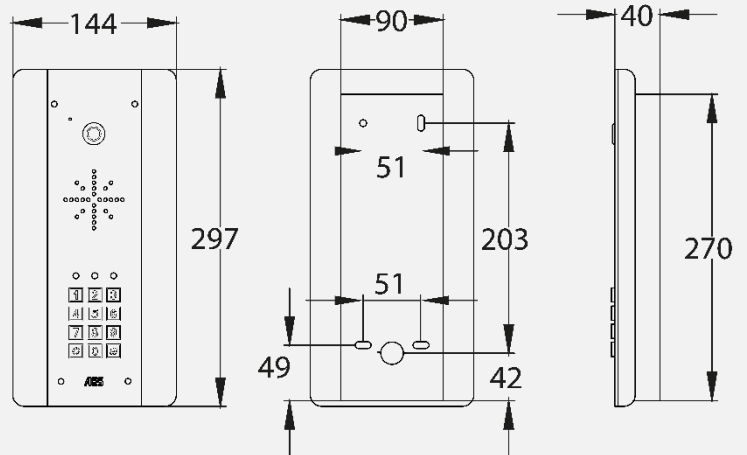

Curved architectural model in an attractive and rugged all brushed BS316 marine grade stainless steel with modern cool white back lighting illumination and integrated keypad.

PRIME6-ASK/4GE	Europe
PRIME6-ASK/4GA	USA
PRIME6-ASK/4GSA	Australia & NZ



Industrial Panel non Keypad

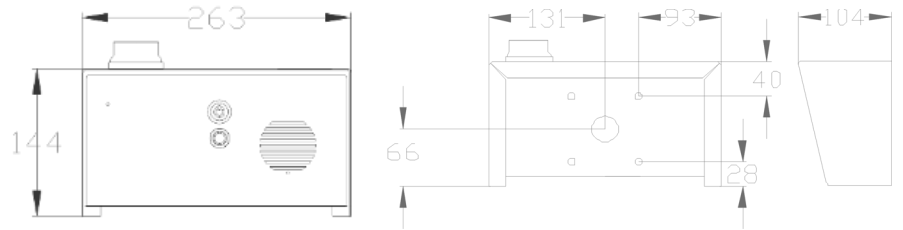

Industrial version with keypad for pedestal mount, vehicle entrances, trucks and loud industrial applications. BS316 marine grade stainless steel construction with gloss black face trim.

PRME6-IMP-PED/4GE	Europe
PRIME6-IMP-PED/4GA	USA
PRIME6-IMP-PED/4GSA	Australia & NZ

Industrial Panel with Keypad

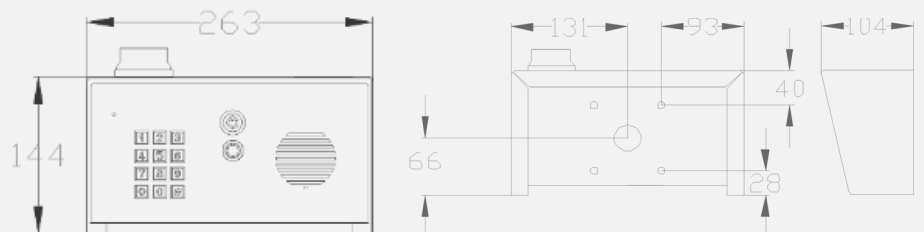

Industrial version with keypad for pedestal mount, vehicle entrances, trucks and loud industrial applications. BS316 marine grade stainless steel construction with gloss black face trim.

PRME6-IMP-K-PED/4GE	Europe
PRIME6-IMP-K-PED/4GA	USA
PRIME6-IMP-K-PED/4GSA	Australia & NZ



CellcomProx

Advanced GSM Intercom



Set automatic gate open & close times.



Do-not-disturb watershed time.



User history log to your phone.



Add up to 200 cards or tags to intercom remotely by SMS text or app!



Add up to 20 time restricted tags or cards by app!



Add keypad codes by app.



Issue time restricted codes.



High gain antenna as standard!



2x Relays.

Technical Details

Dial Out Numbers	4	Relays	2
Permanent Codes	200	Relay Type	N/C and N/O
Time Restricted Codes	20	Relay Load	2 amps 24v ac max
Temporary Codes	30	Power Consumption	300mA on dial out, 2amp peak demand
Automatic Trigger Events per Week	40	Modem Models	4G Europe, 4G USA, 4G AUS/NZ
Caller ID Numbers	100	Tag/Card Type	125kHz fixed digit code card, passive type
Time Restricted Caller ID Numbers	20	Tag/Card Quantity	*1200
Power Supply	24v ac/dc (24v 2A dc adaptor included)		



Non Keypad Prox Panels

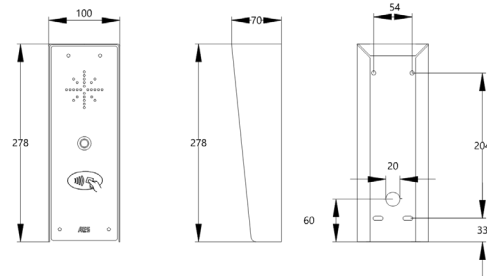

Ultra stylish all black panel with textured powder coated aluminium hood and gloss black acrylic facia trim over a tough metal back plate. Complete with modern white illuminated push button and integrated Prox reader. Kits complete with 3 proximity cards with additional cards available to purchase.

PRIME6-PX-IMP/4GE	Europe
PRIME6-PX-IMP/4GA	USA
PRIME6-PX-IMP/4GSA	Australia & NZ

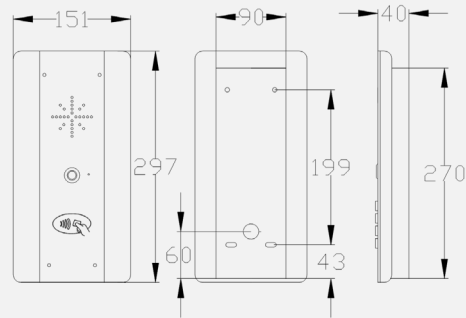

Stylish curved architectural model. Constructed from BS316 marine grade stainless steel and finished with gloss black acrylic trim. Complete with modern blue illuminated push button and integrated Prox reader. Kits complete with 3 proximity cards with additional cards available to purchase.

PRIME6-PX-AB/4GE	Europe
PRIME6-PX-AB/4GA	USA
PRIME6-PX-AB/4GSA	Australia & NZ

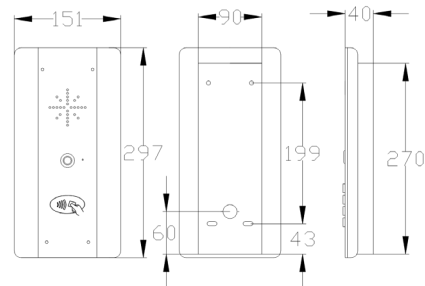

Stylish curved architectural model. Constructed from BS316 marine grade stainless steel. Complete with white illuminated push button and integrated Prox reader. Kits complete with 3 proximity cards with additional cards available to purchase.

PRIME6-PX-AS/4GE	Europe
PRIME6-PX-AS/4GA	USA
PRIME6-PX-AS/4GSA	Australia & NZ



Keypad Prox Panels

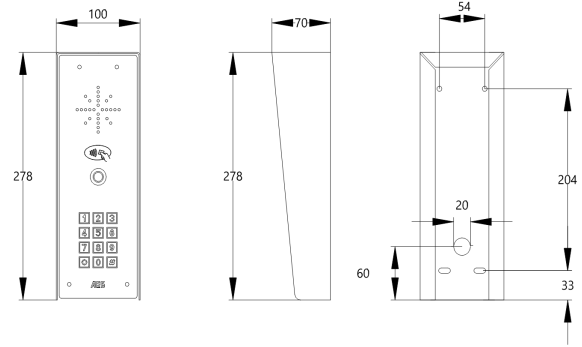

Ultra stylish all black panel with textured powder coated aluminium hood and gloss black acrylic facia trim over a tough metal back plate. Complete with modern white illuminated push button, keypad and integrated Prox reader. Kits complete with 3 proximity cards with additional cards available to purchase.

PRIME6-PX-IMPK/4GE	Europe
PRIME6-PX-IMPK/4GA	USA
PRIME6-PX-IMPK/4GSA	Australia & NZ

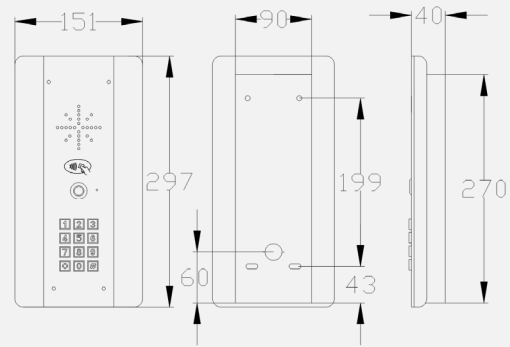

Stylish curved architectural model. Constructed from BS316 marine grade stainless steel and finished with gloss black acrylic trim. Complete with modern blue illuminated push button, keypad and integrated Prox reader. Kits complete with 3 proximity cards with additional cards available to purchase.

PRIME6-PX-ABK/4GE	Europe
PRIME6-PX-ABK/4GA	USA
PRIME6-PX-ABK/4GSA	Australia & NZ

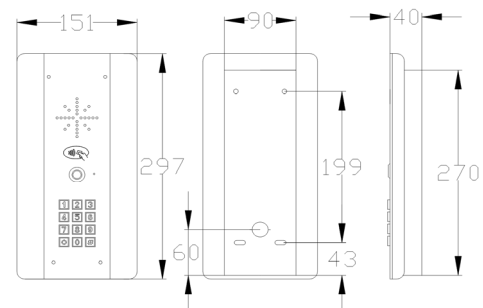

Stylish curved architectural model. Constructed from BS316 marine grade stainless steel. Complete with white illuminated push button, keypad and integrated Prox reader. Kits complete with 3 proximity cards with additional cards available to purchase.

PRIME6-PX-ASK/4GE	Europe
PRIME6-PX-ASK/4GA	USA
PRIME6-PX-ASK/4GSA	Australia & NZ



Industrial Prox Panel non keypad

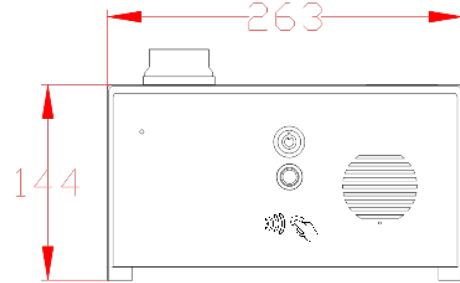

Industrial version for pedestal mount, vehicle entrances, trucks and loud industrial applications. BS316 marine grade stainless steel construction with gloss black face trim. With built in proximity reader.

PRME6-PX-IMP-PED/4GE	Europe
PRIME6-PX-IMP-PED/4GA	USA
PRIME6-PX-IMP-PED/4GSA	Australia & NZ

Industrial Prox Panel with Keypad

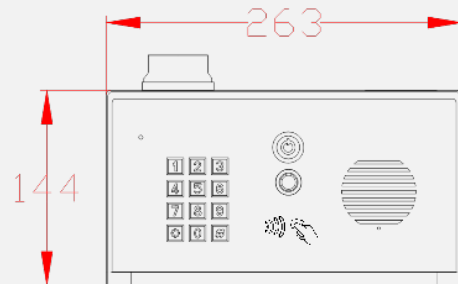

Industrial version with keypad for pedestal mount, vehicle entrances, trucks and loud industrial applications. BS316 marine grade stainless steel construction with gloss black face trim. With built in proximity reader.

PRME6-PX-IMPK-PED/4GE	Europe
PRIME6-PX-IMPK-PED/4GA	USA
PRIME6-PX-IMPK-PED/4GSA	Australia & NZ



PROXCARD-125K-AES



Single Proximity Card
 -125KHz fixed 10 digit code Card.
 -Add to intercom remotely by SMS text or APP.

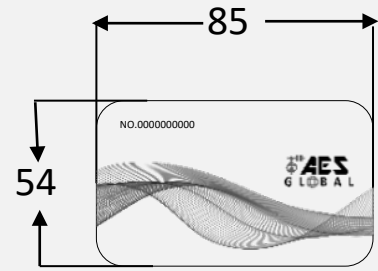

PROXCARD-125K-AES-10PK



10 Pack Proximity Card
 -125KHz fixed 10 digit code Card.
 -Add to intercom remotely by SMS text or APP.

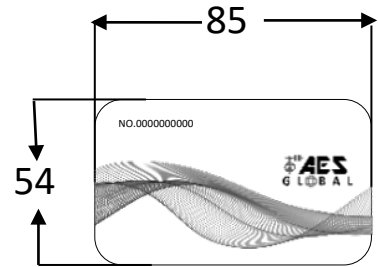

PROXCARD-125K-AES-50PK

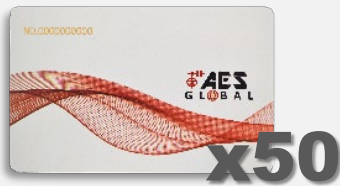

50 Pack Proximity Card
 -125KHz fixed 10 digit code Card.
 -Add to intercom remotely by SMS text or APP

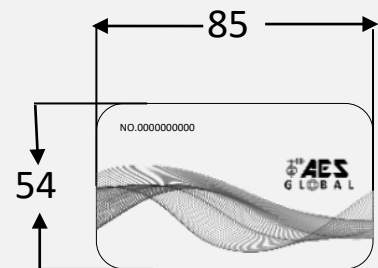

AES-PROX-TAG

AES branded Prox Tags.
 -125KHz fixed 10 digit code TAG.
 -Available in packs of 10, 25, 50, 100

